



Crystal Merchandiser® RVMC24D Specs

Medium Temp Reach-In Remote Display Cases

2-Door, 3-Door, 4-Door, and 6-Door Cases; Rear Load (RL) Cases

Quick Specs

Energy (Btu/h per Door)*

Standard: 410 at 28°F Evaporator

*when used with parallel rack system

Merchandising (6-Door)

Facings: 69.8 ft²

Packout: 156.5 ft³ with 24" x 24" deep shelves

Features & Options

Go Green

Remote cases ready for CO₂

High Humidity

Control climate challenges with our advanced humidity package

CoolView® Doors

24" wide x 74" tall CoolView® Ultra® Doors

LED Lighting

ChillBrite® 3500K and 4000K LED Lighting

Additional Models

The Crystal medium temp with 24" French doors offers a standard, rear load, deep, deep rear load, ultra-narrow, and back-to-back ultra-narrow model

Hybrid™ Display Case

Available as Hybrid™ cases with R-404A or R-448A

Applications



Beverage



Dairy



Produce



Meat

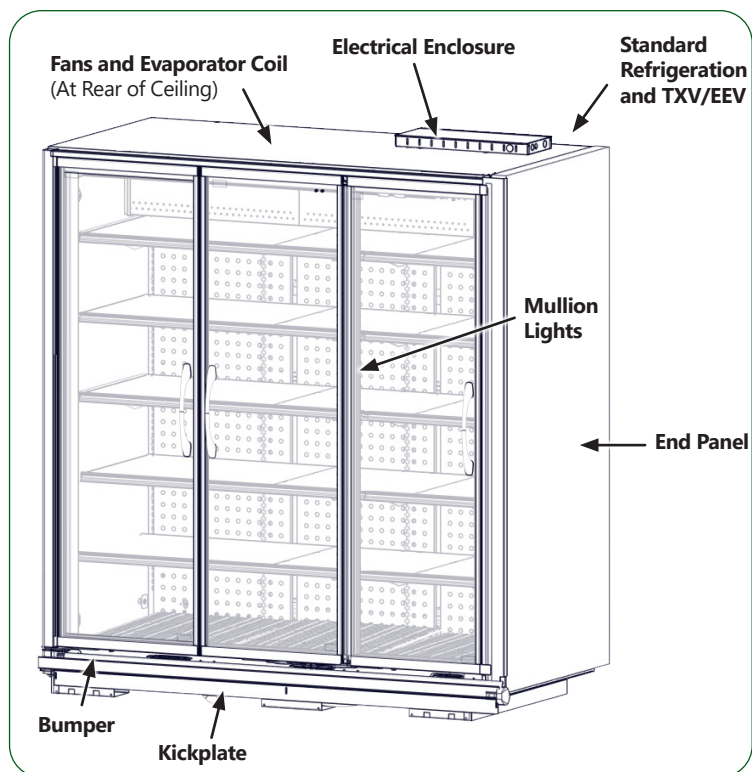

Manuals and Instructions:
<https://www.zero-zone.com/rvmc-rvlc>



Contact Us:

800-247-4496

www.zero-zone.com

Specifications are subject to change without notice. All dimensions are nominal.
 Case designed to operate in an ambient temperature of 75°F and relative humidity of 55% or lower.



SS-29 Rev Q • 3/20/2024

© 2024 Zero Zone, Inc.

Page 1 of 5





Refrigeration Data ¹

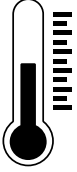

Set Points	°F
Evaporator Temperature ²	28
Discharge Air Temperature (w/ 8°F Superheat)	33

Notes:

1. Crystal Merchandiser® Rear Load cases must be installed in front of the opening in a walk-in cooler.
2. For high-glide refrigerants, use dew point for unit sizing. Adjust evaporator pressure as needed to maintain discharge air temperatures.



Energy Use with Parallel Rack System ³	Lineup Data	Individual Case Data (includes 1 pair of end panels)			
	Per Door Avg	2-Door	3-Door	4-Door	6-Door
RVMC24D Baseline Btu/h	410	930	1,360	1,740	2,570
RVMC24DRL Baseline Btu/h	410	930	1,360	1,740	2,570
Energy Use with Condensing Unit ³	Per Door Avg	2-Door	3-Door	4-Door	6-Door
RVMC24D Baseline Btu/h	445	1,005	1,470	1,880	2,775
RVM24DRL Baseline Btu/h	445	1,005	1,470	1,880	2,775
Btu/h Adders	Per Door Avg	2-Door	3-Door	4-Door	6-Door
Rail Heated Doors (Zero Zone CoolView® Ultra®)	+10	+20	+30	+40	+60
Rail & Glass Heated Doors (Zero Zone CoolView® Ultra®)	+30	+60	+90	+120	+180
End Panels	Btu/h Per Case				
Glass Windowed End Panel (1-Pair) ⁴	+410				

Notes:

3. Baseline Evaporator Btu/h based on LED lighting (Zero Zone ChillBrite® 4000K), standard-energy doors (Zero Zone CoolView® Ultra®), and ECM or SSC electronic fan motors.
4. Glass windowed end panels only available with 2 1/2" end panels.

Glycol Data ⁵	2-Door	3-Door	4-Door	6-Door
Flow Rate (GPM)	0.6	0.8	1.2	1.8
Pressure Drop (PSIG)	2.0	3.3	6.1	5.8

Notes:

5. All Glycol data based on 35% propylene glycol by weight, 20°F supply temperature, and 23°-24°F outlet temperature.

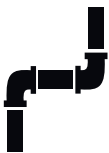

Refrigeration Piping: R-404A & R-448A ⁶	Outlet Size (in.)			
	2-Door	3-Door	4-Door	6-Door
Suction Line O.D. (Top Refrigeration Exit)	1/2	1/2	1/2	1/2
Liquid Line O.D.	3/8	3/8	3/8	3/8
Refrigeration Piping: CO ₂ ⁶	2-Door	3-Door	4-Door	6-Door
Suction Line O.D. (Top Refrigeration Exit)	3/8	3/8	3/8	3/8
Liquid Line O.D.	3/8	3/8	3/8	3/8

Notes:

6. Read the Installation & Operation Manual for more about refrigeration piping to properly size individual risers for circuits of more than one case.



Electrical & Energy Data ⁷



Fan Motors (115V)	Per Door Avg		2-Door		3-Door		4-Door		6-Door	
Number of Fans	--		2		2		2		3	
Fan Motors (115V)	Amps	Watts	Amps	Watts	Amps	Watts	Amps	Watts	Amps	Watts
High-Efficiency Electronic (ECM or SSC)	0.42	8	0.84	15	0.84	22	.84	25	1.26	31
Lighting System (120V)	Amps	Watts	Amps	Watts	Amps	Watts	Amps	Watts	Amps	Watts
Same-Swing Doors (Fig. 1: Options A & B)	0.16	19	0.33	39	0.48	58	0.64	77	1.00	115
French-Swing Doors (Fig. 1: Options C, D, E, F for 3-Door)	0.15	18	0.30	36	0.53	64	0.60	72	0.90	108
Anti-Sweat Heat (115V)	Amps	Watts	Amps	Watts	Amps	Watts	Amps	Watts	Amps	Watts
No-Energy Doors (Zero Zone CoolView® Ultra®)	0.00	0	0.00	0	0.00	0	0.00	0	0.00	0
Rail Heated Doors (Zero Zone CoolView® Ultra®) ⁸	0.05	6	0.09	10	0.14	16	0.19	22	0.28	32
Rail & Glass Heated Doors (Zero Zone CoolView® Ultra®)	0.16	18	0.31	36	0.47	54	0.63	72	0.94	108

Notes:

- 7. Amps are based on electrical nameplate values. Watts are based on laboratory observations of actual energy use.
- 8. High-humidity package includes glass heat, rail heat, and mullion heat.

Physical Data



Merchandising	2-Door	3-Door	4-Door	6-Door
Facings (ft. ²)	23.7	35.2	46.7	69.8
Packout (ft. ³) 24" Shelves	48.1	71.5	95.1	141.9
Packout (ft. ³) 27" Shelves	53.0	78.8	104.8	156.5
Shipping Weight without End Panels	2-Door	3-Door	4-Door	6-Door
RVMCD Weight (lbs.)	775	933	1,020	1,254
RVMCDRL Weight (lbs.)	775	933	1,020	1,254
Shipping Weight with End Panels	2-Door	3-Door	4-Door	6-Door
RVMCD Weight (lbs.)	835	993	1,080	1,314
RVMCDRL Weight (lbs.)	835	993	1,080	1,314
Shipping Weight with Windowed End ⁹	2-Door	3-Door	4-Door	6-Door
RVMCD Weight (lbs.)	885	1,043	1,130	1,364
RVMCDRL Weight (lbs.)	885	1,043	1,130	1,364

Notes:

- 9. Each solid end panel: 30 lbs. Each Windowed End: 55 lbs.

FIG. 1: 3-Door Configuration Options

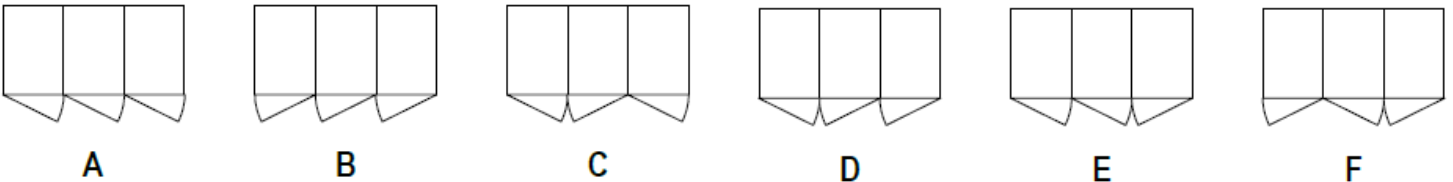



Crystal Merchandiser® RVMC24D Remote Specs

RVMC24D and RVMC24DRL

RVMC24D Top View

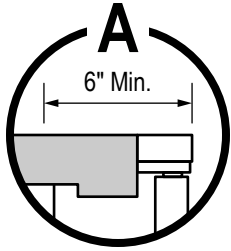

Building soffits must be set back at least 6" from the front of the doors to allow access to electrical wiring on the top of the case.

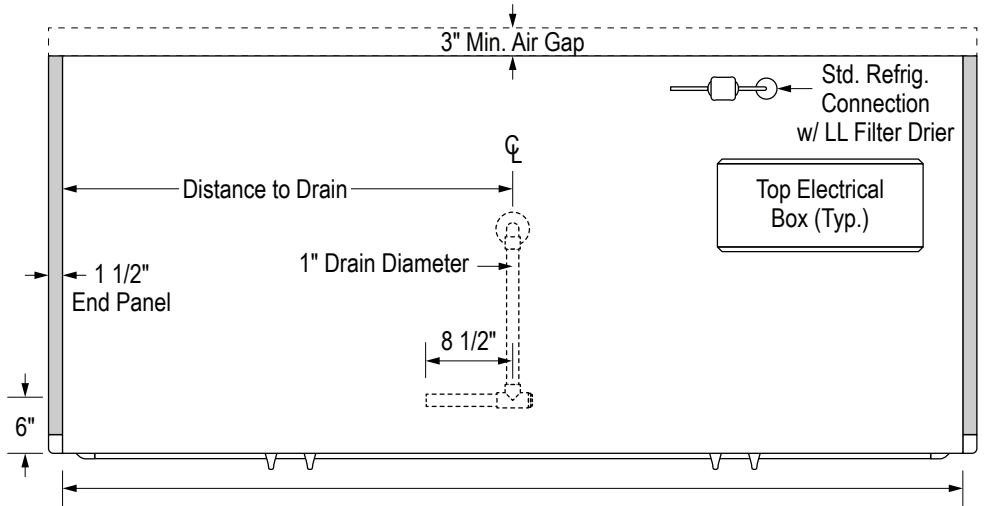

Case Dimensions

Measurements	2-Door	3-Door	4-Door	6-Door
Case Length (in.) without End Panels	48 3/4	72 1/2	96 3/8	143 7/8
Case Length (in.) with End Panels	53 3/4	77 1/2	101 3/8	148 7/8
Distance to Drain (in.) without End Panels	24 3/8	36 1/4	48 1/8	71 7/8

RVMC24D End View

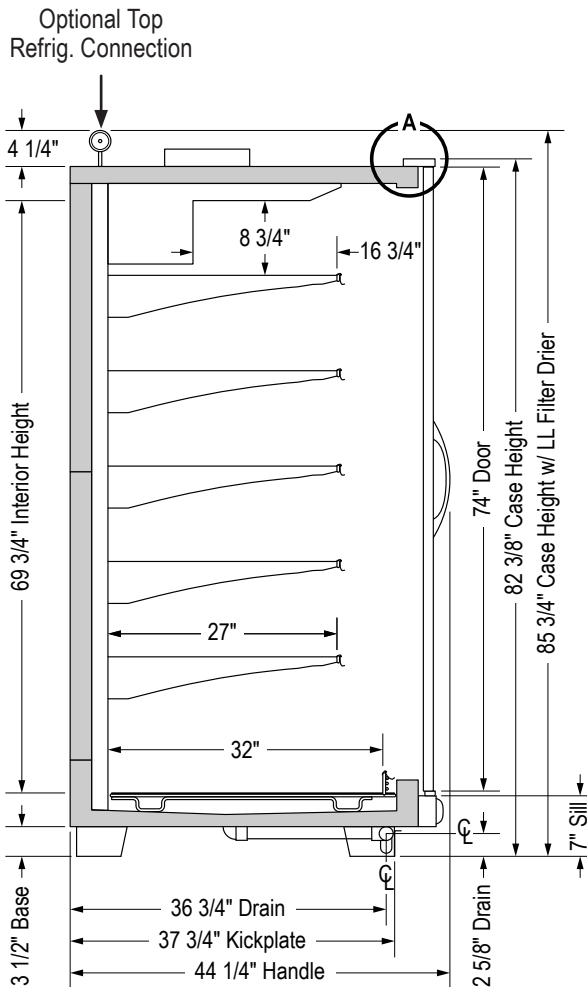



RVMC24DRL Rear Load Top View

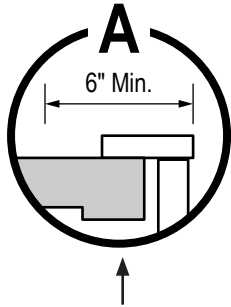

Building soffits must be set back at least 6" from the front of the doors to allow access to electrical wiring on the top of the case.

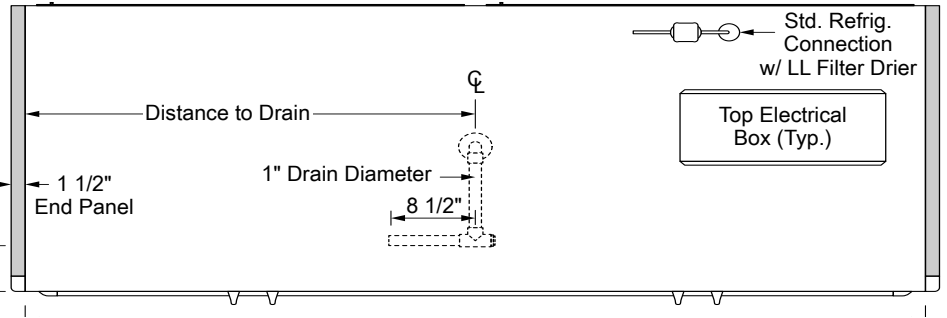

Case Dimensions

Measurements	2-Door	3-Door	4-Door	6-Door
Case Length (in.) without End Panels	48 3/4	72 1/2	96 3/8	143 7/8
Case Length (in.) with End Panels	53 3/4	77 1/2	101 3/8	148 7/8
Distance to Drain (in.) without End Panels	24 3/8	36 1/4	48 1/8	71 7/8

RVMC24DRL End View

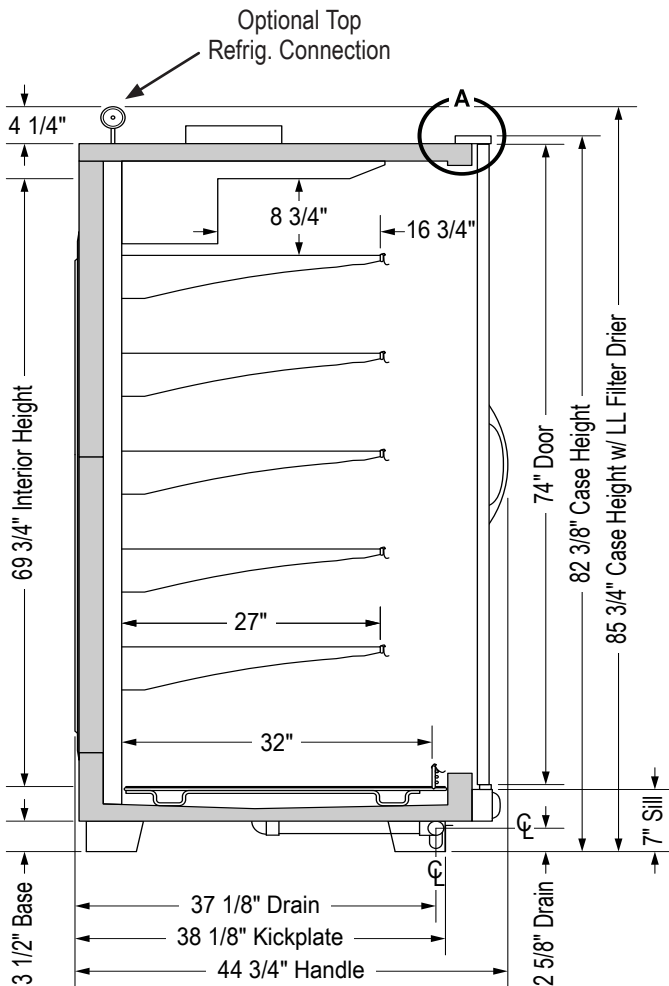

RVMC24DRL Rear View

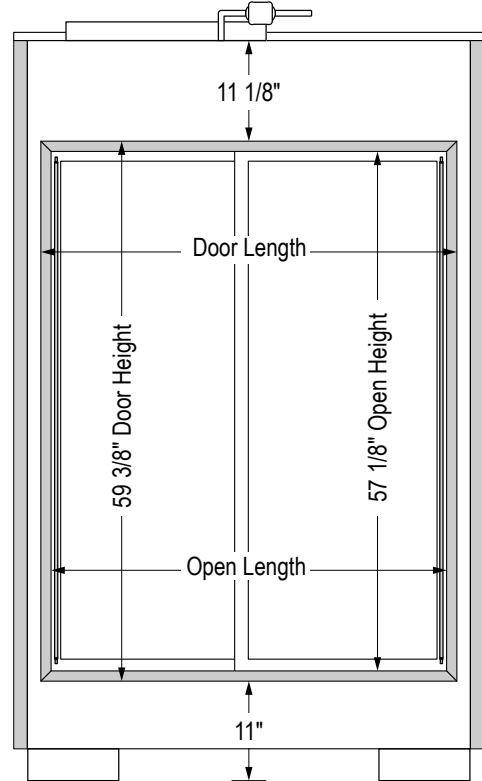

Rear Load Dimensions

Measurements	2-Door	3-Door	4-Door	6-Door
Door Length (in.)	45 3/4	69 1/2	93 7/8	141 3/8
Open Length (in.)	43 1/2	67 1/4	91 1/2	139 1/8